

FULL MOTION DUAL STUD MOUNTS

FMX3

Behold the bigwig of articulating wall mounts.

The FMX3 is Kanto's flagship full motion TV wall mount. For flat screen displays measuring up to 90" and weighing less than 150 lb, this mount gives you amazing range of motion, letting you enjoy your TV to the fullest.

Featuring up to 28" of extension and coming pre-assembled with dual heavy-duty steel arms, the FMX3 is simple to install and offers incredible extension, tilt, and swivel capabilities.

Enjoy your enormous TV in style.

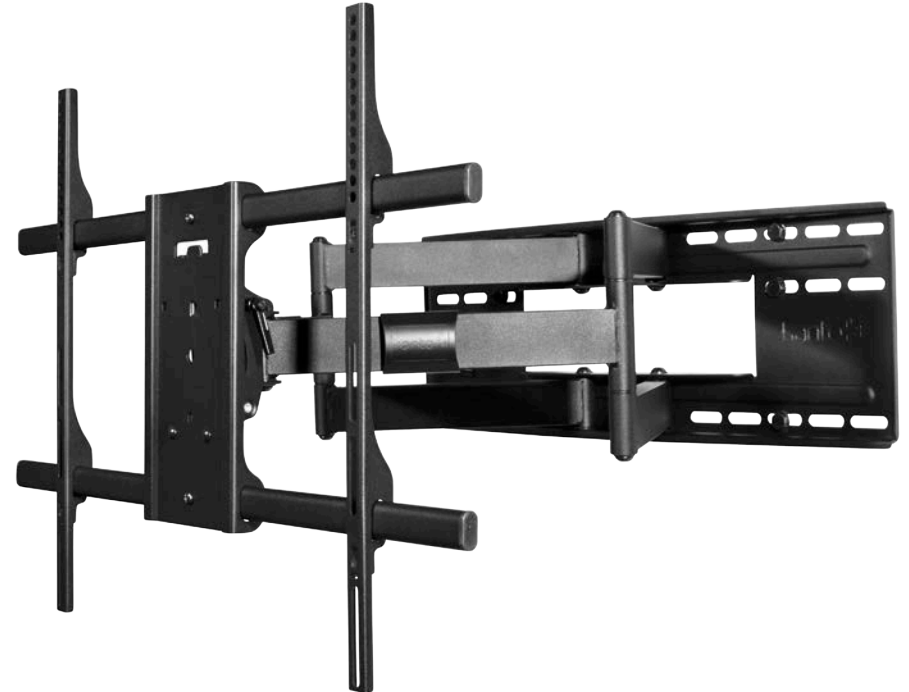

FEATURES & SPECIFICATIONS

- Fits most flat panel TVs from 40" to 90"
- Supports TVs up to 150 lb (68 kg)
- Accommodates VESA sizes from 200x100 to 700x500
- Accessible tilt mechanism provides a +15° to -5° tilt angle
- 80° of swivel in either direction, dependent on screen size.
- Sits 4" (10 cm) from the wall
- Extends up to 28" (71 cm) from the wall
- Integrated cable management system
- Adjustable horizontal leveling
- 26.8" (68 cm) dual stud wall plate accommodates up to 24" stud spacing
- Includes paper wall template for marking pilot holes
- Installation manual and all mounting hardware for wood stud and concrete installation is included
- Five year warranty
- Shipping box weight: 32.1 lb (14.6 kg)
- Shipping box dimensions: 31.5" x 12.8" x 4.1" (80 cm x 32.5 x 10.5 cm)
- Product weight: 29 lb (13.2 kg)
- UPC: 800152015590

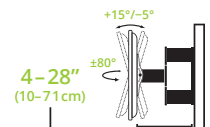
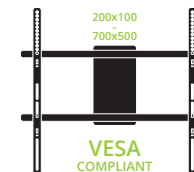
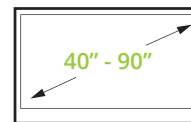

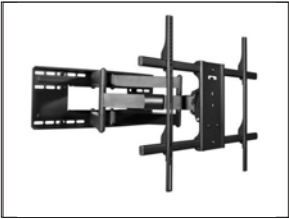

SUPPORTS 150 POUNDS

With its solid steel construction, the FMX3 is designed and tested to hold up to 150 pounds. Even with your TV at the maximum weight at full extension, your TV will remain in place with no sag.



28 INCHES OF EXTENSION

Pull your TV an amazing 28" out from the wall – ideal to pull a TV out of a recess, and to allow modest swivel for even an 90" TV.

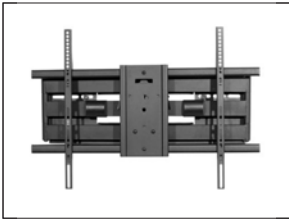

FITS VESA SIZES TO 700x500

The FMX3 accommodates a range of VESA patterns from 200x100 to 700x500.

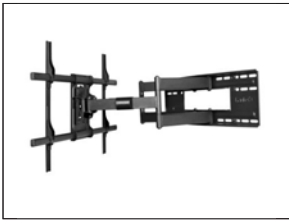

WIDE RANGE OF SWIVEL

The articulating arms allow you to swivel your TV 80° in either direction, depending on your TV size, allowing you to achieve the perfect viewing angle.

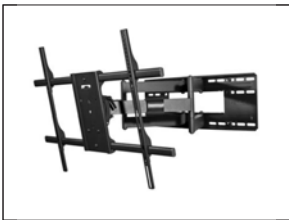

20 DEGREES OF TILT

The tilt mechanism is easily accessible, and uses a spring-loaded lever system that requires no tools. Tip your TV forward up to 15° or backward 5°, and you can quickly tighten the head in place at your desired viewing angle.



EVERYTHING YOU NEED

We supply you with everything except a toolbox to ensure that your installation goes smoothly. Instruction manuals are provided in English, French, and Spanish, as well as the parts you need to mount your TV safely and securely. Easy-to-follow online videos and phone support are available to assist you along the way.

TECHNICAL ILLUSTRATIONS

